



FOTO 16



FOTO 17



FOTO 18



FOTO 19

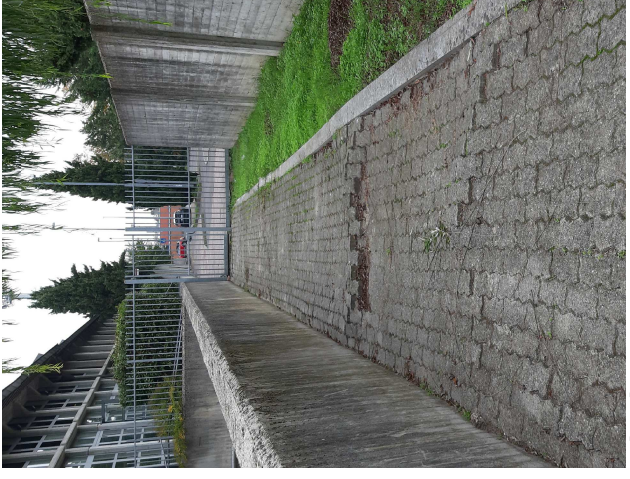

FOTO 20



FOTO 21



FOTO 22



FOTO 23



FOTO 1



FOTO 2

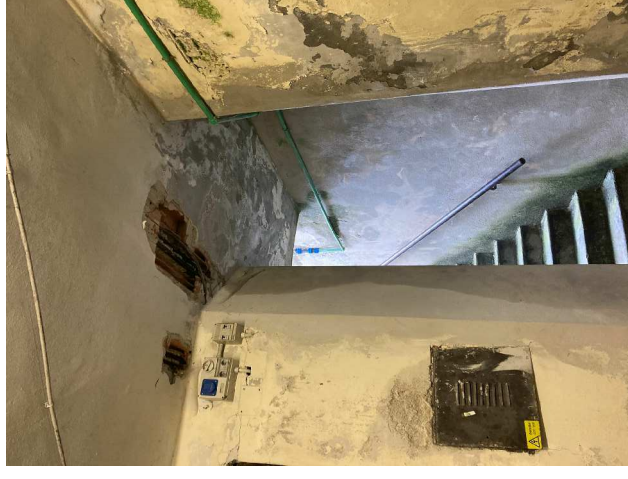

FOTO 3

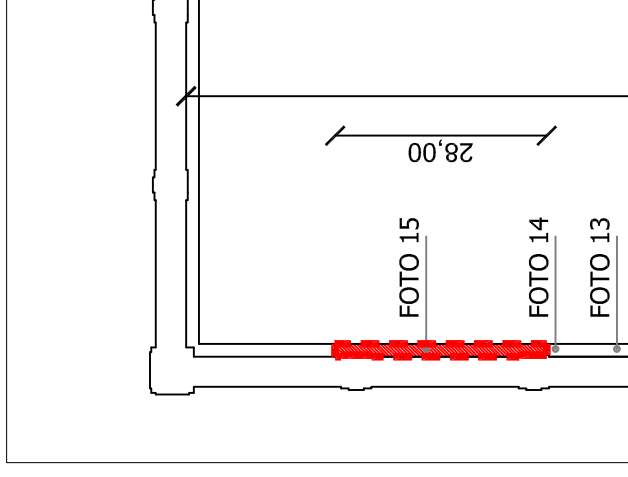

FOTO 4

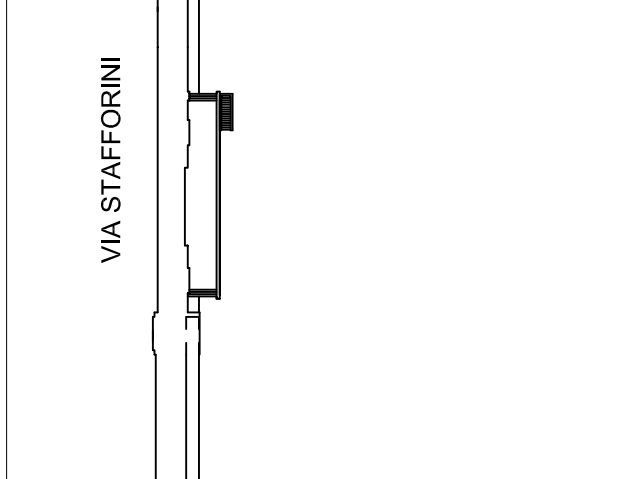

FOTO 5

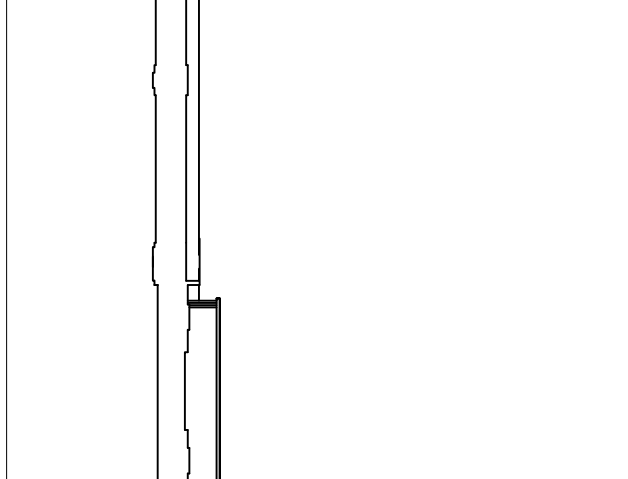

FOTO 6

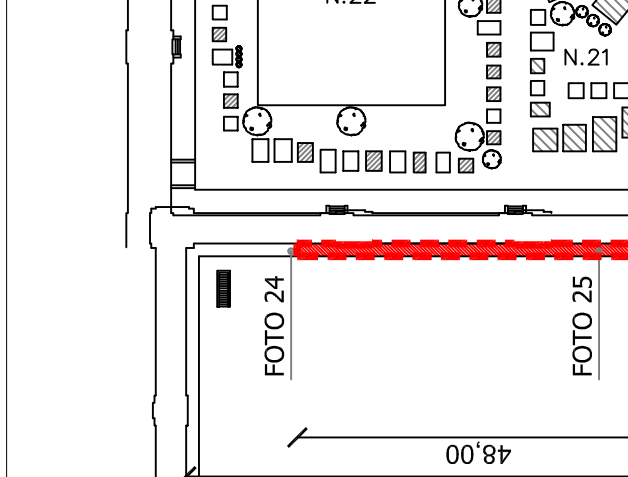

FOTO 7

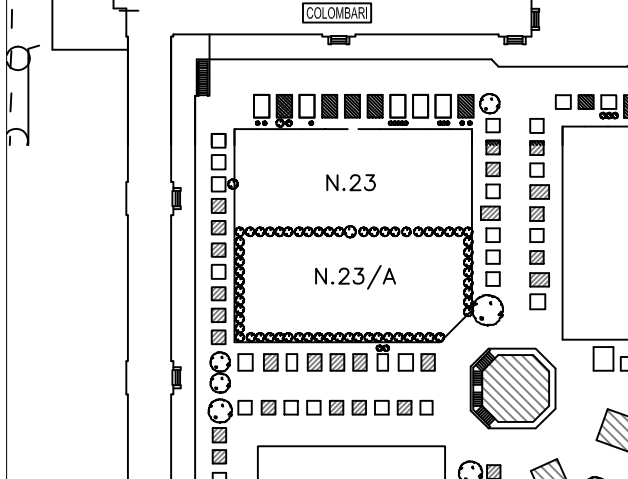

FOTO 8

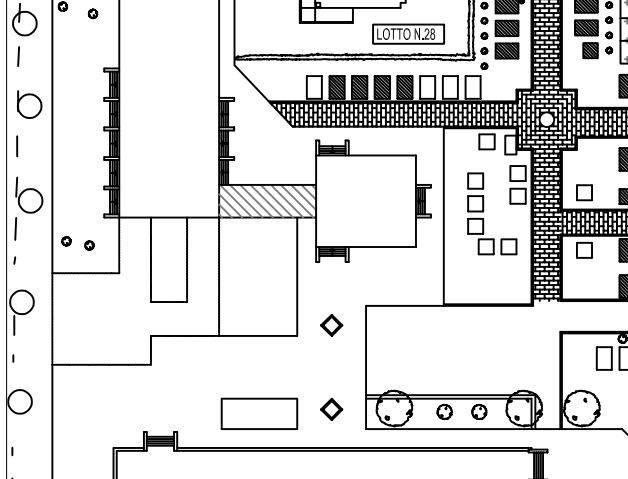

FOTO 9

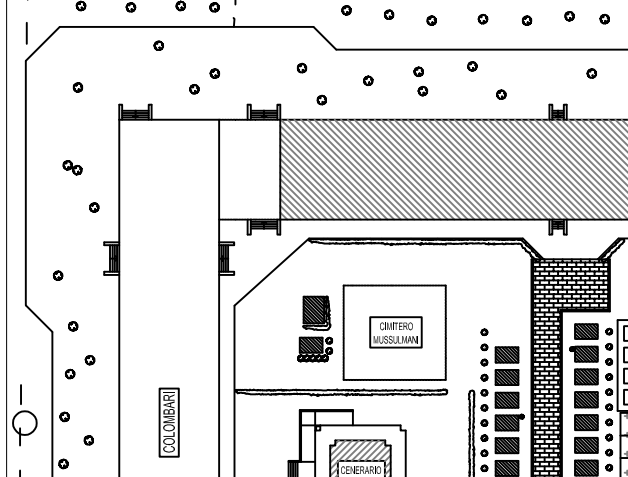

FOTO 10



FOTO 11

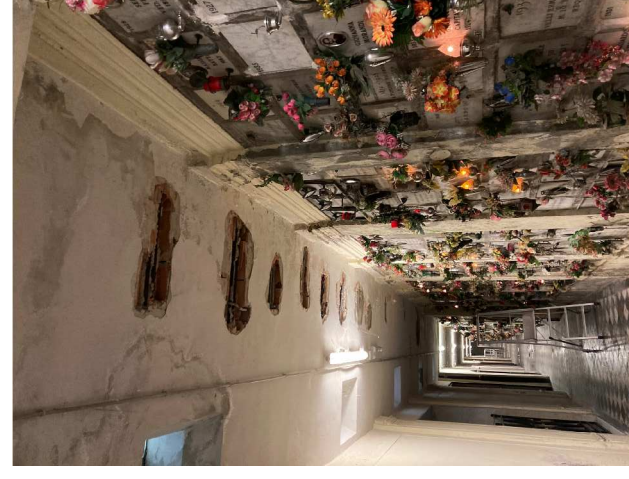

FOTO 12

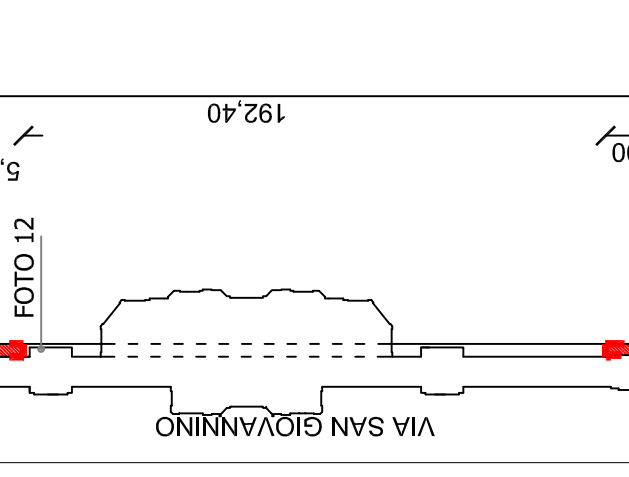

FOTO 13



FOTO 14



FOTO 15

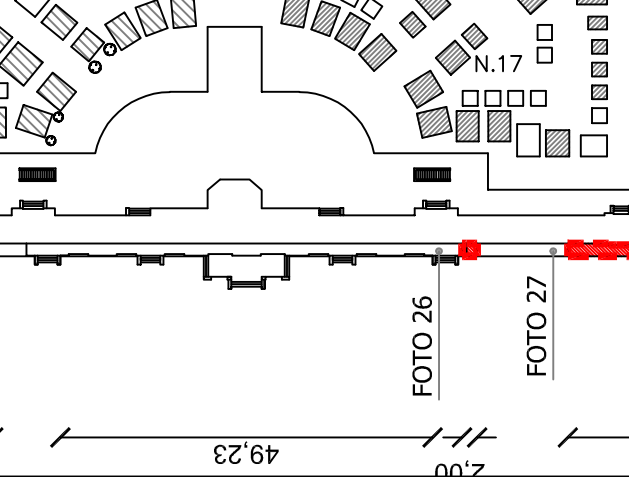

FOTO 16

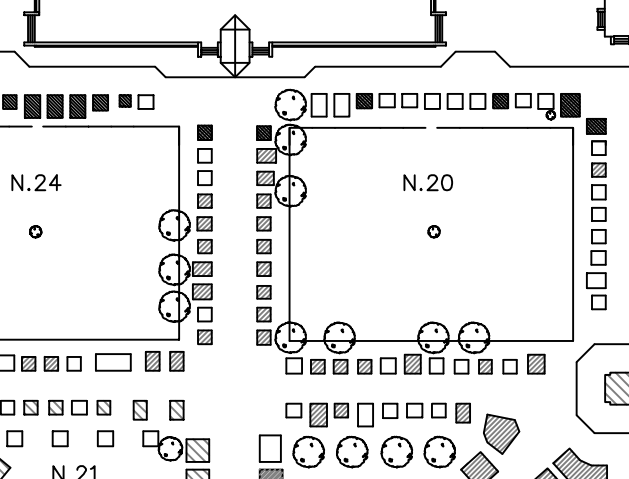

FOTO 17

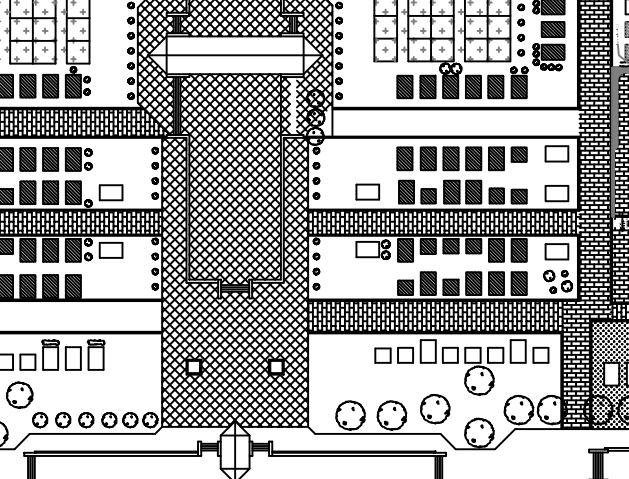

FOTO 18

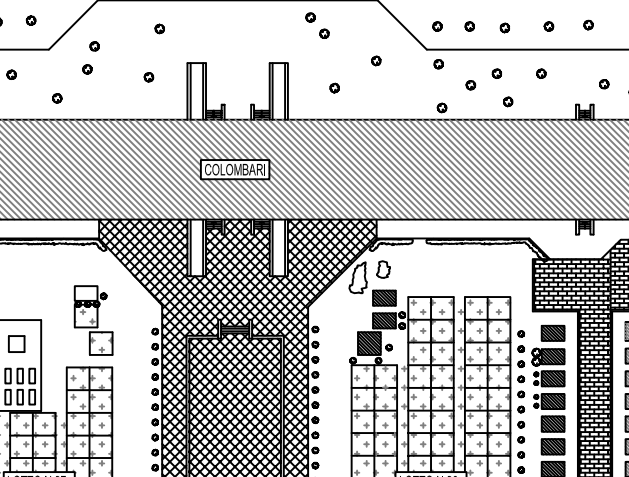

FOTO 19



FOTO 20



FOTO 21

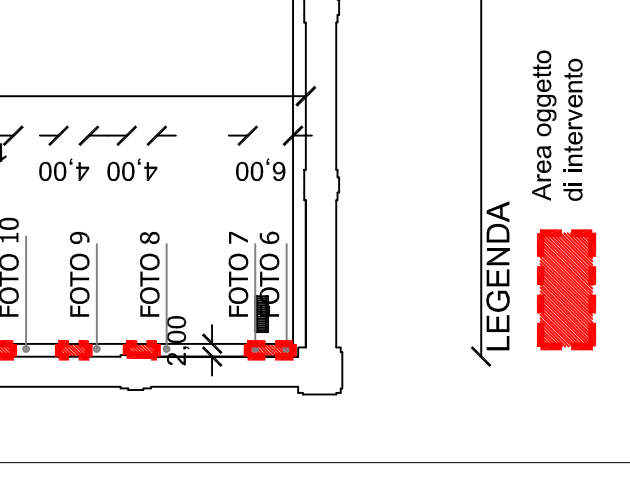

FOTO 22

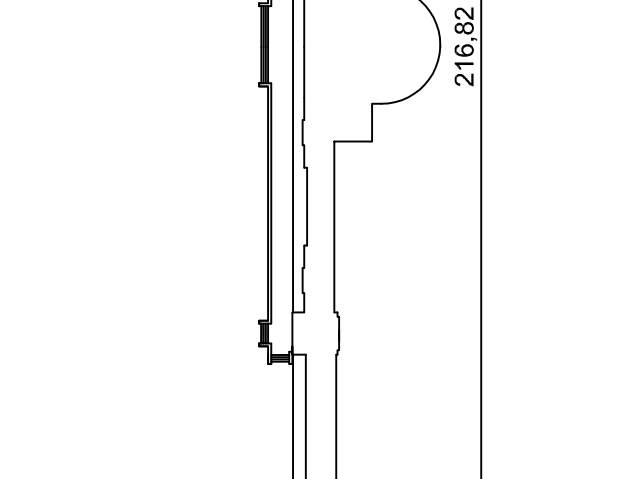

FOTO 23

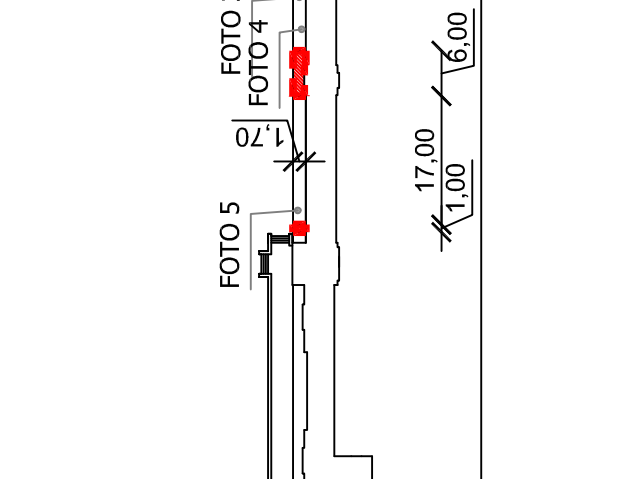

FOTO 24

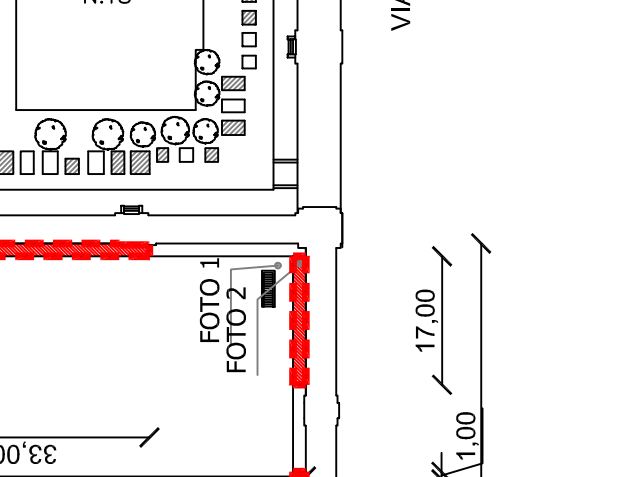

FOTO 25

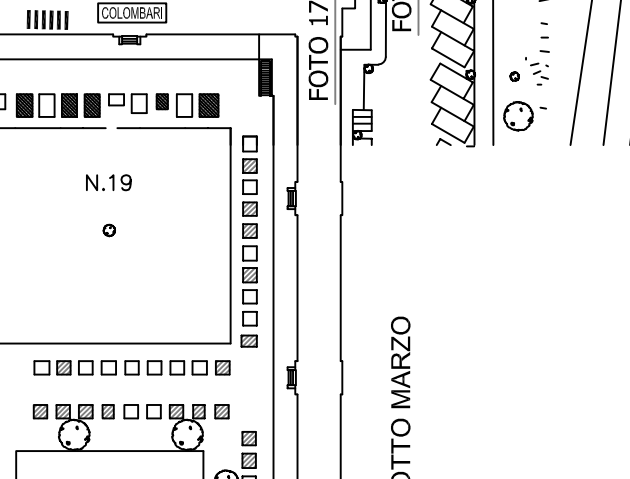

FOTO 26

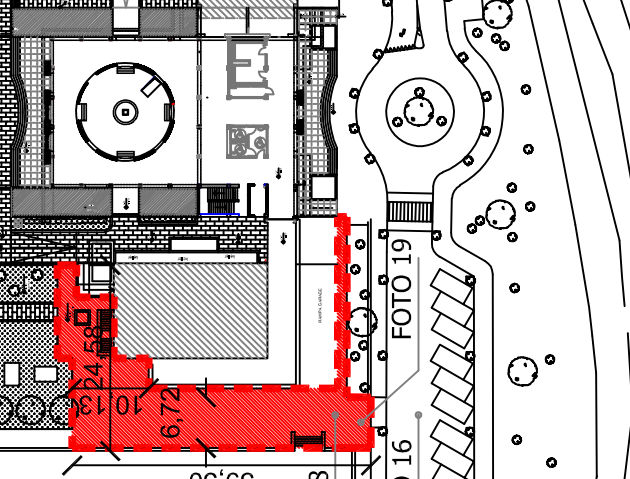

FOTO 27

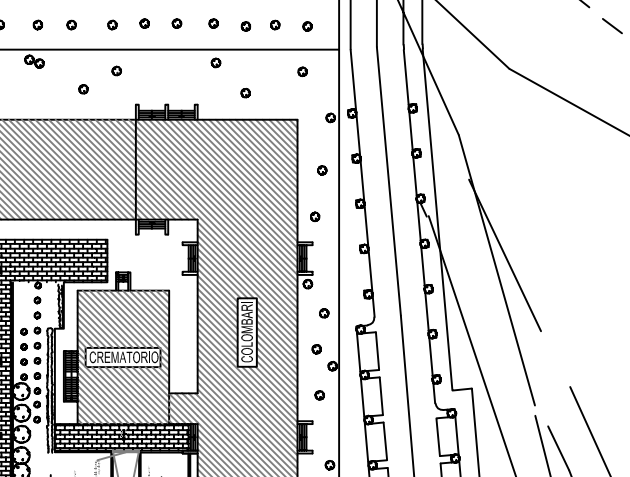

FOTO 28

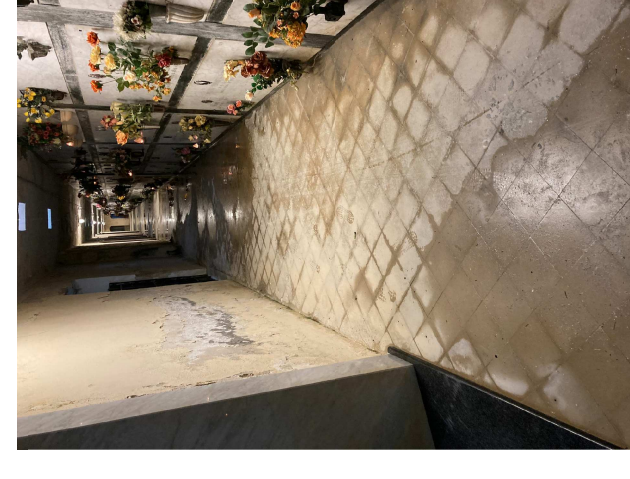

FOTO 29

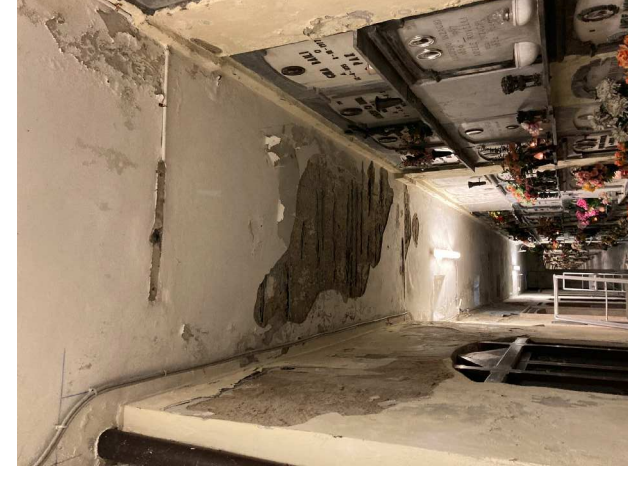

FOTO 30



FOTO 31

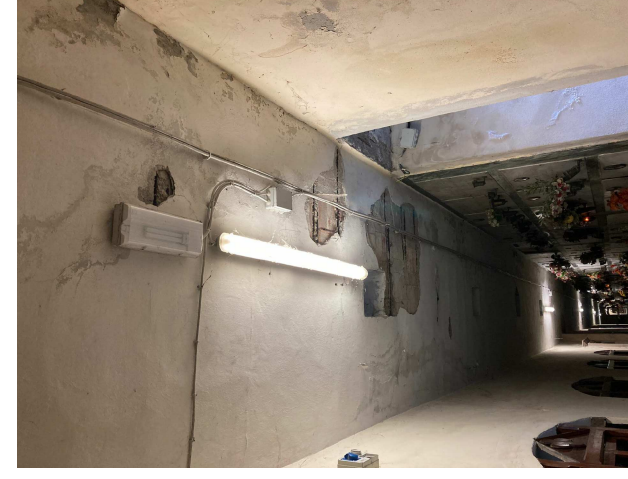

FOTO 32

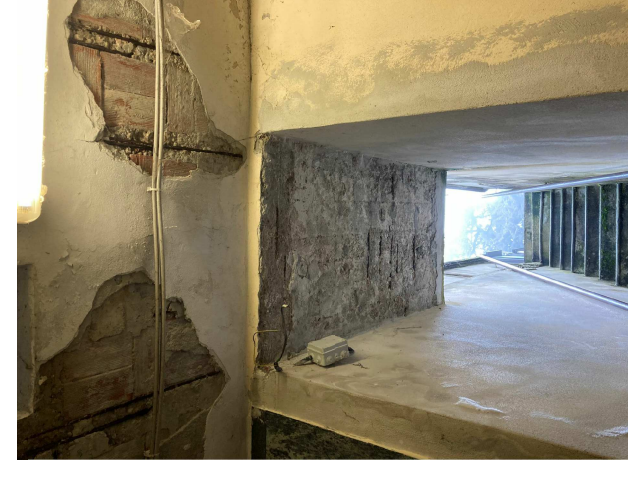

FOTO 33



FOTO 34



FOTO 35



FOTO 36



ORTOFOTO

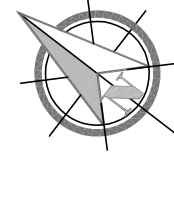

COMUNE DI PAVIA  
Via Scopoli 1 - 27100 Pavia  
Cod. Fisc. e p.IVA 00296180185 - PEC: protocollo@pec.comune.pv.it

### SETTORE 6 LAVORI PUBBLICI, MANUTENZIONI, ESPROPRI, MOBILITA'

LAVORI DI MANUTENZIONE STRAORDINARIA CIMITERO MAGGIORE



I PROGETTISTI  
Ing. Sara Garavani - Arch. Vanessa Asolli  
IL RESPONSABILE DEL PROCEDIMENTO  
Ing. Adriano Sora

IL DIRIGENTE DEL SETTORE 6  
Arch. MARA LATINI

Documento firmato digitalmente ai sensi del D.Lgs. 82/2005 e smi

**OGGETTO:**

OPERE DI MANUTENZIONE STRAORDINARIA DEI SOTTERRANEI  
DEL QUADRATO STORICO DEL CIMITERO MONUMENTALE CON  
RIPRISTINO DEI SOLAI E INTONACI  
CUP: G17H21035200004

**DATA:**  
Novembre 2021

Codice  
Intervento  
**POP339**  
SCALA  
1:1000

**PROGETTO ESECUTIVO:**  
Rilievo fotografico e stato di fatto  
CIMITERO MAGGIORE

All. 3

TAVOLA:

01